

auto electrical parts

Technical Information Sheet

Part No. 0-326-52

2 pole black and grey nylon 90° Schlemmer connector.
Supplied with terminals and seals for use on 10NW tubing.

M27 DIN with grey cap nut.



Technical Drawing (not to scale)

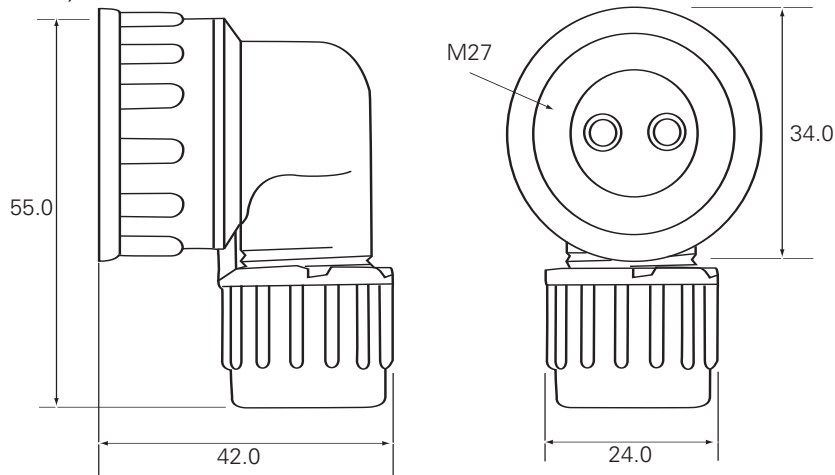

Specification

Type	2 pole connector
Connector nut	M27
Tubing size	10 NW
Material - housing	Nylon (polyamide 6)
- connector seals	Neoprene
- terminal	Nickel plated brass
Terminal	4mm female Crimp contact
Cable size	1.0 - 2.5mm ²
Temperature range	-25°C to + 80°C
Protection	IP67

The information contained in this document is correct to the best of our knowledge at the time of printing. However, specifications may change at any time without notice.